



ISSN 2047-3338

# A Device Pair Classification based Channel Slot Re-Utilization Optimization for Scalability Enhancement in Wireless Mesh Network

Asha C. N., and T. G. Basavaraju

**Abstract**—Wireless mesh networks (WMNs) are multihop systems which can develop the scope of remote systems, with the benefits of fast and easy deployment, high transfer speed, simple establishment and upkeep, low front expense. They are potential methods to assemble the cutting edge remote correspondence frameworks. IEEE 802.11 standard is currently the most commonly used radio technique for WMNs. Due to tremendous growth of the wireless based application services are increasing the demand for wireless communication techniques that use bandwidth more effectively. Channel slot re-utilization in multi-radio wireless mesh networks is a very challenging problem. WMNs have been adopted as back haul to connect various networks such as Wi-Fi (802.11), WI-MAX (802.16e) etc. to the internet. The slot re-utilization technique proposed so far suffer due to high collision due to improper channel slot usage approximation error. To overcome this here the author propose the cross layer optimization technique by designing a device classification based channel slot re-utilization routing strategy which considers the channel slot and node information from various layers and use some of these parameters to approximate the risk involve in channel slot re-utilization in order to improve the QoS of the network. The simulation and analytical results show the effectiveness of our proposed approach in term of channel slot re-utilization efficiency and thus helps in reducing latency for data transmission and reduce channel slot collision.

**Index Terms**—Multi-radio WMN, Radio Channel Measurement, Scheduling, Routing and Medium Access Control (MAC)

## I. INTRODUCTION

WMN is very attractive area for researchers in current time due to its flexibility. WMN has flexible infrastructure, it provide end to end communication between the nodes which is far away. WMN has improved from one hop to multi-hop connectivity between the communications ends. In current era wireless network gain much attention;

research is ongoing day-by-day to improve more and more wireless technologies. WMN is a part of this technologies growth. The IEEE 802.11s MAC is the standard for mesh communication in wireless personal area network. WMN has a quality of dynamically self-organized and it can self-configure which make it more popular than other wireless network. Multi-hop transmission is one more characteristic of WMN. In a wireless Mesh network, there is fixed infrastructure over fixed wireless network which is used by wireless host. Every wireless host is connected with any of the mesh node; some mesh node may have direct association with internet. Channel quality in WMN fluctuated due to Doppler Effect, fading and interference [1].

Using IEEE 802.11s standard WMN in free frequency bands for wireless communications traffic has the following issue the need to be addressed as in [12] such as Speed of mobile devices. Physical and transport levels of IEEE 802.11s developed for fixed stations, where high speed can lead to large and rapid changes in channel conditions, which in turn increases the probability of frame error (FER). This occurrence is due to the Rayleigh fading channel [11]. Distance: IEEE 802.11s is used for association over short or long distances. Due to these drawbacks there is a requirement in a great number of base stations to cover the entire network. Generally 802.11s transmits a variety of message and control frames for the communication or for network authentication before transmitting data info. Handover is also difficult to implement due to the high speed of devices on the network, where the handoff occurs in a frequent manner among the base station for the entire network. When designing a Mesh network appear the following problematic such as it is difficult to predict the number of subscribers on the mesh network at varied time. Difficulties in predicting the amount of traffic generated by devices, hence the total system capacity. The wireless channel is stochastic and time-varying according to different parameters.

MAC provides the actual benefit of mesh network. MAC-layer protocol by default chooses the minimum available transmission rate and it does not protect from error. Mesh network based on CSMA/CA MAC protocol which has single hop transmission characteristics, cannot provide the quality of service for the application which is streaming in real time like voice calling, video calling, etc. CSMA/CA has some limitation due to which we need a new MAC protocol which

Asha C N, Assistant Professor in the Department of Electronics and Communication Engineering, Acharya Institute of Technology, Bangalore. She is a PhD research Scholar at Visvesvaraya Technological University (VTU), Belgaum. (Email: ashcan@acharya.ac.in).

T G Basavaraju, Professor and Head in the Department of Computer Science and Engineering, Government SKSJ Technological Institute, K R Circle, Bangalore. Previously he was with Natioanl Institute of Technology Karnataka, Surathkal. (Email: tg.braju@gmail.com).

gives better throughput, capacity and reduce delay. To achieve better QoS it is needed to use the Time division multiple access (TDMA) based approach in MAC layer. Total channel (frequency channel or single band) is split into time-frame slot in TDMA scheduling and assignment of transmitting slot to the node is done. Power drop, collision, data overhead is prevented by every time slot [2]. TDMA with distributed approach consist of two different procedures. In first procedure it based on Bellman ford algorithm [3], each node find a nearest feasible link, which are taken from two-hop routing information updated by neighbor node. In second approach nearest feasible schedule is used to analyze the global feasible schedule and it inform the availability of a new schedule to the entire node.

Number of MAC-layer multicast mechanism was proposed for mesh network to overcome the inefficiency of the network. Hop-by-hop recovery on loss of packet is provided by researchers in various ways. Here [4] author gives the analysis of maximized output for a wireless mesh network over CSMA/CA in MAC layer protocol. Random access is not accounted in CSMA due to which collision overhead is increased. New development for optimal capacity analysis of network done in CSMA/CA with multi commodity flow (MCF), author analyze throughput based on upper and lower bound of the network capacity over CSMA/CA. the drawback of CSMA/CA is that it is not suitable for real time data transfer like video calling. In [5] if physical rate is increases efficiency of the MAC layer is decreases. More efficient MAC layer protocol in terms of scalability still has issues. Proposed scheme by author is MAC protocol based on dual channel token called (DT-MAC). This protocol is suitable for large number of user in terms of scalability and efficiency. Token management is extra overhead for network and it is not suitable for upper layer.

In [6] wireless mesh network high throughput need a TDMA based approach. TDMA support multichannel transmission, schedule dissemination and routing integration. TDMA based on routing metrics and stability of routing metrics. Experiment shows that it controls the network overhead and it not affected by external interference. It is not useful for large network. In [3] TDMA each frame is associated with some slot, and non –conflicting link is transmitted through these slots. Iterative procedure is used to find the nearest feasible schedule by exchanging the link information between nodes. Another part is work on wave based termination which is used to detect the scheduled nearest node and if any new node is scheduled which is activated. Spatial-TDMA [9] used for reduced the energy consumption and improve the throughput author formulate offline energy –throughput by the tradeoff curve. Physical interference involved where node used for controlling the power. Author work is based on single channel or single node; it is not feasible for multi-channel or multiple node scenarios.

To overcome the above short coming here the author proposes an adaptive cross layer based slot channel re-utilization optimization to improve the QoS of WMNs. The

slot re-utilization helps in reducing latency of data delivery but there is a chance or risk of channel slot collision to some other devices that may join late to the wireless mesh network. To address this here the author proposes a node classification based slot re-utilization technique to reduce latency and propose robust wireless mesh tree architecture.

The paper organization is as follows: The list of symbol used is presented in section two. The literature survey is presented in section three. The proposed channel slot re-utilization models are presented in Section four. The results and the experimental study are presented in the section five. The concluding remark is discussed in the last section.

## II. LIST OF SYMBOL USED

TABLE I  
PARTIAL LIST OF SYMBOL USED

Notation	Representation
$R$	Area of $S$
$S$	Region where WMN nodes are deployed
$s$	It is the effective range of communication
$p$	Probability the a device is physical neighbor of another devices
$P_x$	$P(x, y)$ for the instance of $P(x, y) \in NCLRP$
$P_y$	$P(x, y)$ for the instance of $P(x, y) \in CLRP$
$P_z$	$P(x, y)$ for the instance of $P(x, y) \in DIRP$
$P(x, y)$	It is the probability risk expected for future device being a victim of slot re-utilization among $x$ and $y$
$V(x, y)$	Area of a region jointly covered by device $x$ and $y$
$l(x, y)$	Represent physical distance among $(x, y)$
$n$	Neighbour device
$a$	Nodes $y$ 's number of neighbor

## III. LITERATURE SURVEY

Use There are several MAC based slot scheduling approaches for use with multihop networks, including WMNs and ad-hoc networks has been developed in recent times in order to reduce the collision and latency and provide QoS to its end user which are surveyed below.

It is understood that in the setting of WMNs, an arbitrary access based MAC convention, for example, CSMA/CA can't give QoS to applications, for example, streaming of real-time multimedia content [25]. A TDMA-based methodology is important for low jitter and delay and to achieve good throughput.

Here [7] author works for high throughput and reliable mesh network in multi-hop transmission. Reduce network bandwidth in multicast tree. Author presents a distributed and centralized algorithm for tackle the problem of multicasting. Obtained result from expected multicast transmission count (EMTX) method, shows the effectiveness it reduces the number of hop-by-hop transmission per packet, but it not considerable for real life or realistic scenario.

A hierarchical based mesh tree protocol given in [10] achieves efficient routing at the MAC layer. Optimal route is chosen by the using of mesh tree topology. The used new HMTP also used for maintaining the update of new route formed. The HMTP topology overcomes the drawback of cluster-tree.

In [8] improvement of QoS by avoiding the network congestion, an algorithm is designed for that prediction of congestion is done before it really happen by using different data, analysis of network and used the historical data of traffic to generate idea of future network traffic. Through network traffic data, load balancing is done to avoid congestion in wireless mesh network. But author purposed algorithm is inefficient to response network congestion properly.

In [24] here they presented an application of LiT-MAC that adopted a transmission based on multi-hop TDMA MAC by adopting Wi-Fi platforms. The conducted their evaluation by means of application level performance as well as micro benchmarks for both indoor and outdoor scenarios. They also presented an integration of their proposed work with numerous routing metrics and evaluated and compared with ROMA [18] and SLIQ [19]. There outcomes shows that the slot time of TDMA is as low as 2ms and has better time synchronization through varied hops thus reducing the control overhead of network. The conducted simulation sturdy for over several days and used 9 devices by considering the outdoor scenario and the result shows that their proposed approach is robust even in the occurrence of external interference but drawback of this approach is they did not special reuse due to this it underutilize to enhance the network capacity of WMNs.

In [21] proposed a pairwise synchronization methodology which is alike a LiT-MAC, and this methodology estimate the clock difference among corresponding device by considering propagation delay among the devices. It makes utilization of a guard band to represent handling delays experienced while data transmission, and keeps out estimations to exactly descant the estimation of the guard band. In view of the estimations completed on an indoor scenario, it reports synchronization exactness of the request of microseconds at three hops.

In [22] they showed Spatial reuse of channel slot is the important and efficient way to reducing the packet transfer latency. In [22] they recommended utilizing the coordinator to gather area data of all routers or relay nodes and figure out which gathering of routers can utilize the same reference point space without signal impacts. They displayed the guideline for space reuse yet did not detail how to acknowledge it. In [23] they examined the issue of discovering an impact of collision free scheduling for 802.15.4 tree infrastructure system that minimizes the latency. They demonstrated that this issue is NP-hard and proposed two heuristic scheduling strategies, in particular concentrated tree based task and distributed slot assignment. Centralized tree based task requires complete topology data as info and is very little superior to distributed slot assignment.

It is seen from literature that the existing mac scheduling

methodology for mesh network suffers from improper utilization of channel slots. Slot re-utilization is one of the possible and effective techniques that help in utilizing the channel slot efficiently. To overcome the short coming here the author propose an efficient cross layer based channel slot re-utilization optimization based on node classification technique to improve the QoS of WMNs.

#### IV. PROPOSED MODEL

The Here the author proposes an adaptive cross layer based slot channel re-utilization optimization to improve the QoS of WMNs. The slot re-utilization helps in reducing latency of data delivery but there is a chance or risk of beacon collision to some other devices that may join late to the wireless mesh network. To address this here the author proposes a node classification based slot re-utilization technique to reduce latency and propose robust wireless mesh tree architecture as shown in below Fig. 1.

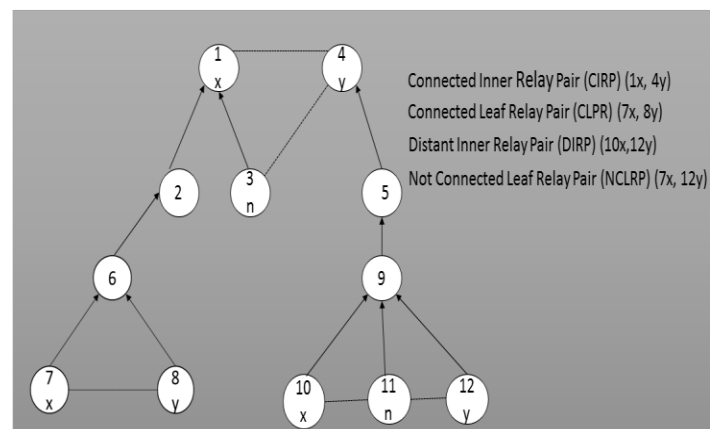

Fig. 1. Proposed device pair classification for WMN Tree

##### A. Proposed node classification for slot re-utilization for WMN

Here the author classifies the device pair based on the information of parenthood and neighborhood relationship. The classified device pair  $(x, y)$  is as follows

**Connected inner relay node pair (CIRP):** Here  $x$  and  $y$  are adjacent device that exist physically in the WMN, and either  $x$  and  $y$  are not adjacent device; or, either  $x$  or  $y$  has a child, but  $x$  and  $y$  have a conjoint adjacent device which is a child of either  $x$  or  $y$ .

**Connected leaf relay node pair (CLRP):** Here  $x$  and  $y$  are adjacent devices that exist physically in the WMN, but neither  $x$  nor  $y$  has any child.

**Distant inner relay node pair (DIRP):** Here  $x$  and  $y$  are not adjacent devices physically but have a conjoint adjacent physical devices in common, although all these adjacent physical devices are neither  $x$ 's nor  $y$ 's children.

**Non-connected leaf node pair (NCLRP):** Here  $x$  and  $y$  are not adjacent physical devices, neither do they have adjacent physical devices in common.

If an occurrence of channel slot re-utilization causes slot

collision to nodes which is already WMN and this instance will cause failure in data transmission. A channel slot re-utilization among a pair of devices  $x, y$  is Impacted (harmful) only if  $x$ 's and  $x$ 's channel slot can cause collision at a node  $n$  which at present is a child device of one of the  $x$  or  $y$  devices. Hence, channel slot re-utilization by *CIRP* are destructive and thereby it is not considered or not allowed by any known channel slot scheduling system.

A channel slot re-utilization among a pair of devices  $(x, y)$  is unsafe if it can reduce available relay router for a forthcoming device  $n$ . One likely reason for the decreasing is that  $n$  is considered to be a conjoint neighbor device of  $x$  and  $y$  that exists physically. Due to this reason channel slot-reutilization by *CIRP*, *CLRP*, and *NCLRP* are all unsafe. A channel slot re-utilization by  $(x, y) \in \text{NCLRP}$  is considered to be unsafe if  $x$  and  $y$  are adjacent enough to permit among a conjoint physical neighbor device.

For channel slot re-utilization by  $(x, y) \in \text{CIRP}$ , there is added reason for the decreasing of available relay router. An upcoming device ( $n$ ) may receive slot utilization signal from among these devices ( $x$ ) but not from the other devices ( $y$  is a distant inner relay node to  $n$ ). Because slot utilization signal is broadcasted in unidirectional, the slot utilization signals from  $x$  to  $n$  is not obstructed by  $y$ 's communication. Though, if  $y$  have communicate requests to  $x$ , the demands can cause collision to  $y$ 's communication at  $x$  on the same transmission slot. The impact of collision result in transmission communication among  $n$  and  $y$  and thus decreases the amount of relay router that are associable to  $n$ .

Now the author propose channel slot reutilization by *CLRP*, *DIRP* and *NCLRP* when the probability of is risk is small which is explained in below section.

### B. Proposed slot re-utilization for WMN

The important part of our technique is to compute the risk probability of slot re-utilization for a specified pair of devices  $(x, y)$  based on the current parenthood and neighborhood knowledge. The author does not consider the knowledge of the physical distance among  $x$  and  $y$  or the total number of devices. The author consider that the WMN node is deployed in a random manner yet follows even or uniform distribution over a section  $S$ . Let  $R$  be the area of  $S$ . Each node is presumed to have a range of communications range of  $s$ . A section of area in  $S$  is assumed to be enclosed by a node  $x$  and is represented as  $x$ 's coverage if all the point in this network area is within range of communications of  $x$ . The author assumes that  $V(x, y)$  to signify the area of the section concealed by two nodes  $x$  and  $y$ , and use  $l(x, y)$  to signify the physical distance among them.

It is known fact that the radio coverage of a wireless transmitter suffer from path loss phenomenon. A practical radio propagation model may consider random variations in path loss at different direction and location [13] and [14], [16] respectively. Subsequently the packet transmission among pair of devices becomes a probabilistic task with probability distribution utility considering direction or distance among the transmitter and the receiver as a parameter. The proposed

node or device-pair classification and communication evaluation are based on the perception of adjacent physical devices, which represent a binary association considering that the two nodes are either adjacent physical devices or are not. Such an association needs a setup of a thresholding on packet or data reception probability for the decision of adjacent physical devices in accordance to a source or transmitter. Subsequently the sources or transmitter operative range of communications would be uneven. However, we can estimate the lower bound of the range of transmission within which any nodes can have an association with the source or transmitter, or a higher of the range, outside which no nodes will be able to receive the data from sources or transmitter successfully.

The symbolization  $s$  is represented as the lower bound, the upper bound, or the average bound of range of communication, in which case it is essentially the worst case, best case or the mean case risk parameters of the analytical result presented in the following sturdy.

**Scheme 1:** The predictable mesh area of the particular region mutually covered by two devices  $x$  and  $y$  is

$$G|V(x, y)| = \begin{cases} \left(\pi - \frac{3\sqrt{3}}{4}\right)s^2 & \text{if } p(x, y) \leq s. \\ \frac{\sqrt{3}}{4}s^2 & \text{if } s < p(x, y) \leq 2s. \end{cases}$$

A device that is positioned at the edge of  $S$  is expected to cover less area than as part of its coverage in beyond or outside  $S$ . This effect is known as the border effect. To overcome the impact by the border effect the author presents the following analysis considering that the region covered by any device is within  $S$ . If  $S$  represents a rectangle area, the probability can be evaluated by adopting the torus convention methodology [15], which turns a flat rectangle into a torus. With this theory, the link occurrence probability [17] is formulated as  $p = \pi s^2 / R$ . Our fundamental outcome consists of following three Propositions which is presented below.

**Proposition 1:** Consider that the device are distributed uniformly over a region  $S$  of  $R$  size, and  $R \gg \pi s^2$ . Assume a device pair  $(x, y) \in YP$  are using same channel slot when a new device  $n$  join a network which is represented by  $P_Y(x, y)$ . The predictable probability of  $n$  suffer from the risk involved in channel slot re-utilization among device  $x$  and  $y$  is  $P_Y(x, y) = \left(1 + \frac{3\sqrt{3}}{4\pi}\right)p$  where  $p = \pi s^2 / R$ .

Proposition 1 is verified based on the inclusion exclusion principle and the outcome of Scheme 1. It shows that  $P_Y(x, y) \approx 1.41p$ , therefore increase in range of communication involves high probability of collision among devices in  $YP$ .

**Proposition 2:** represented as  $P_Z = (x, y)$  (resp.  $P_X(x, y)$ ) is the probability expected when a device  $n$  joining a network becomes a victim of slot re-utilization among  $x$  and  $y$  when  $(x, y) \in ZP$  (resp.  $(x, y) \in XP$ ). Moreover the predictable probability  $P_X^*(x, y)$  that a device  $n$  joining a network become a fatality or victim of channel slot re-utilization among  $x$  and  $y$  when  $(x, y) \in XP$  considering that  $s < d(x, y) \leq 2s$ . Let  $a$  represent the number of adjacent device of  $y$ , then  $P_Z(x, y)$  and  $P_X(x, y)$  are correlated to  $P_X^*(x, y)$  by:

$$P_Z(x, y) = \frac{\sqrt{3}}{4\pi(1 - \varphi(a))} p - \frac{\varphi(a)}{1 - \varphi(a)} P_X^*(x, y), \quad (1)$$

$$P_X(x, y) = 3pP_X^*(x, y),$$

Where  $p = \pi s^2/R$  and

$$\varphi(a) = \frac{2}{3} \int_{\theta=0}^{2\pi/3} \left[ 1 - \frac{\theta - \sin \theta}{\pi} \right]^a \sin \theta d\theta.$$

Function  $\varphi(a)$  is the predictable probability of all  $y$ 'sa adjacent devices not residing in the region covered by  $x$  and  $y$  considering that  $s < d(x, y) \leq 2s$ . Subsequently  $\varphi(a)$  is reducing in accordance to value of  $a$ ,  $\varphi(a) \leq \varphi(1) = 1 - \frac{\sqrt{3}}{4\pi}$  and  $1 - \varphi(a) \geq 1 - \varphi(1) = \frac{\sqrt{3}}{4\pi}$  for all  $a \geq 1$ . It follows the first term of (1) is lesser than  $1p$  and  $P_Z(x, y)$  hence it is upper bounded by  $p$  for the case of  $a = 1$ .

$$P_Z(x, y) = p - \frac{1 - \frac{\sqrt{3}}{4\pi}}{\frac{\sqrt{3}}{4\pi}} P_X^*(x, y) \geq 0.$$

It follows that

$$P_X^*(x, y) \leq \frac{\sqrt{3}}{4\pi - \sqrt{3}} p \approx 0.16p.$$

Therefore  $P_X(x, y) = 3pP_X^*(x, y) = 0.48p^2$

For a general  $a$ , the integration task of  $\varphi(a)$  requires an intensive computation procedure. Luckily the value of  $\varphi(a)$  corresponding to practical value of  $a$  are pre-calculated and kept in the devices before deployment. These assessment can be checked when  $\varphi(a)$  need to be computed. More notably based on Proposition 2 we can evaluate  $P_X^*(x, y)$ , then we can predict the precise value of  $P_Z = (x, y)$  and  $P_X(x, y)$ . Next based on Proposition 3 we evaluate the  $P_X^*(x, y)$ .

**Proposition 3:** Based on the definition of Proposition 2,

$$P_X^*(x, y) = \int_s^{2s} V(b) \left\{ \frac{\left[ 1 - \frac{V(b)}{\pi s^2} \right]^a \frac{2s}{3s^2}}{\int_s^{2s} \left[ 1 - \frac{V(b)}{\pi s^2} \right]^a \frac{2s}{3s^2}} \right\} db$$

Where

$$V(b) = s^2 \left[ 2 \arccos \frac{b}{2s} - 2 \sqrt{1 - \left( \frac{b}{2s} \right)^2} \left( \frac{b}{2s} \right) \right].$$

From Fig. 2. and Fig. 3. Compares the values of  $P_Z(x, y)$  and  $P_X(x, y)$  respectively are the simulation value obtained based on Proposition 2 and Proposition 3. The simulation effective range of communication is set and the areas are fixed as  $\sqrt{aR/c\pi}$ , and devices are added to the simulation bed until an average degree  $a$  of a device is reached. Our analytical or mathematical result gives a high precision of accuracy. Proposition 3 requires an intensive computation for increase in  $a$ . For a device to compute  $P_X^*(x, y)$  effectively here the author propose the following approximation

$$P_Z(x, y) \approx 0.17p. \quad (2)$$

The value of  $P_X(x, y)$  are largely so low and are considered to be zero i.e....  $P_Y(x, y) \geq P_Z(x, y) \geq P_X(x, y)$  or  $P_X(x, y) \geq P_Z(x, y) \geq P_X \geq P_Y(x, y)$ .

The simulation and analytical study of our proposed approach is evaluated in the below section of this paper.

## V. SIMULATION RESULT AND ANALYSIS

The system environment used is windows 10 enterprises 64-bit operating system with 16GB of RAM. The author have used visual studio Dot net framework 4.0, 2010 and used VC++ programming language. The author has conducted simulation and analytical study for probability analysis for channel slot re-utilization by varying the node size and node degree.

In Fig. 2, below the author computes the simulated probability of  $P_Z(x, y)$  by varying number of node or devices and node degree value. In figure we can see that when we increase the node degree  $a$  value the probability of collision also increases for all node sizes (50, 100, and 200). The probability of collision is high for smaller mesh network size (50) when compared to larger network size (200).

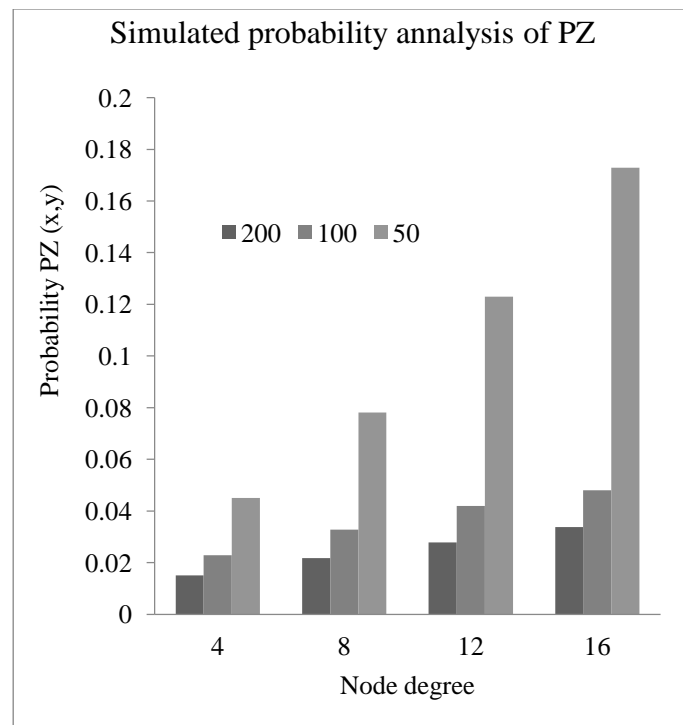

Fig. 2. Simulated probability analysis for  $P_Z(x, y)$

In Fig. 3, below the author computes the simulated probability of  $P_X(x, y)$  by varying number of node or devices and node degree value. In figure we can see that when we increase the node degree  $a$  value the probability of collision also increases for all node sizes (50, 100, and 200). The probability of collision is high for smaller mesh network size (50) when compared to larger network size (200).

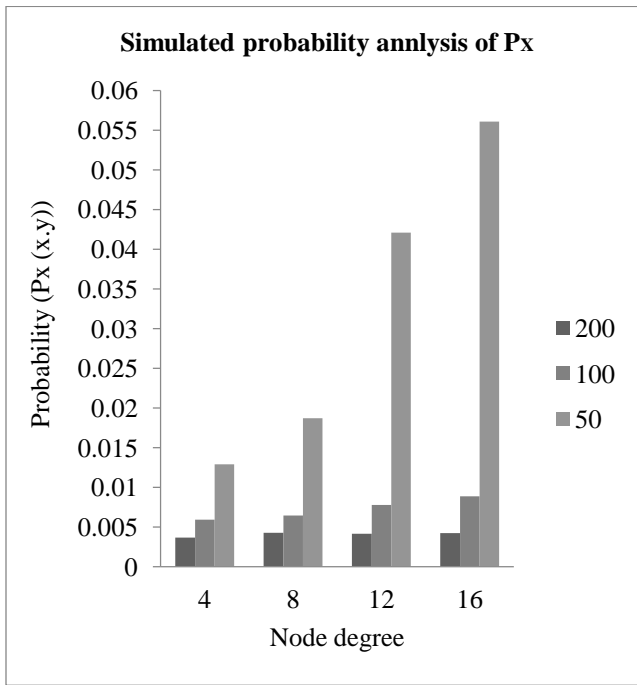

Fig. 3. Probability analysis for  $P_x(x, y)$

In Fig. 4, below the author computes the analytical probability of  $P_z(x, y)$  by varying number of node or devices and node degree value. In figure we can see that when we increase the node degree  $a$  value the probability of collision also increases for all node sizes (50, 100, and 200). The probability of collision is high for smaller mesh network size (50) when compared to larger network size (200).

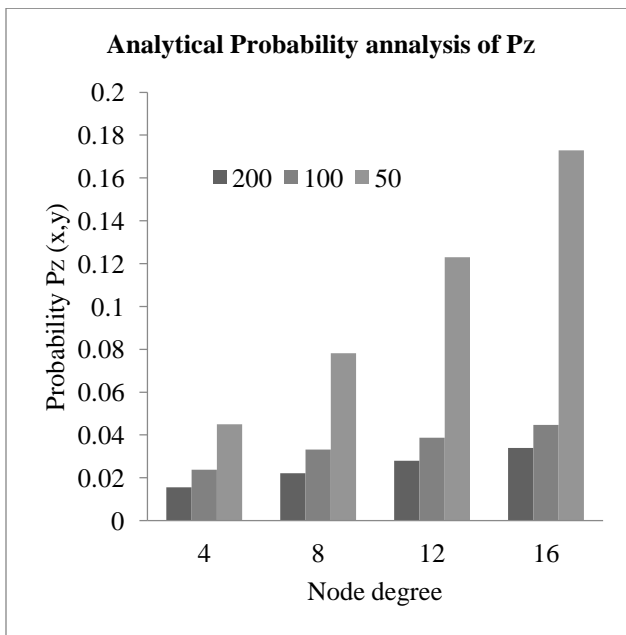

Fig. 4. Probability analysis for  $P_z(x, y)$

In Fig. 5, below the author computes the analytical probability of  $P_x(x, y)$  by varying number of node or devices and node degree value. In figure we can see that when we increase the node degree  $a$  value the probability of collision also increases for all node sizes (50, 100, and 200). The probability of collision is high for smaller mesh network size (50) when compared to larger network size (200).

increase the node degree  $a$  value the probability of collision also increases for all node sizes (50, 100, and 200). The probability of collision is high for smaller mesh network size (50) when compared to larger network size (200).

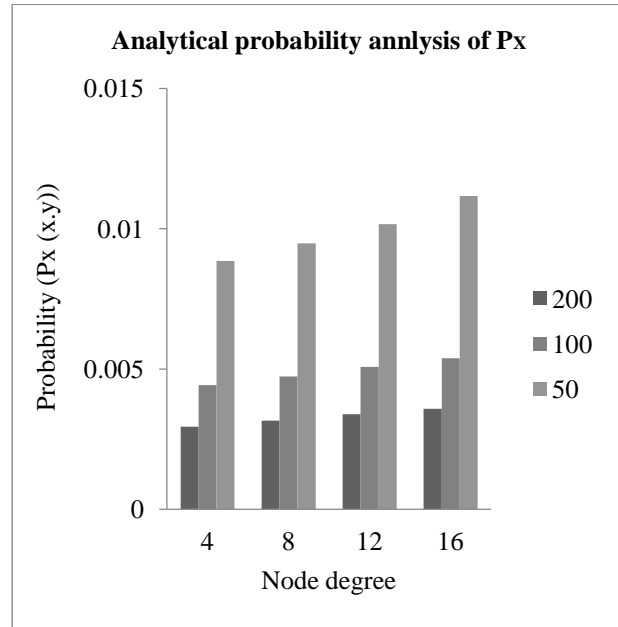

Fig. 5. Probability analysis for  $P_x(x, y)$

In Fig. 6, below the author computes the simulated and analytical probability of  $P_z(x, y)$  by varying number of node or devices and node degree value. In figure we can see that when we increase the node degree  $a$  value the probability of collision also increases for all node sizes (50, 100, and 200). The probability of collision is high for smaller mesh network size (50) when compared to larger network size (200). And also we can see that simulation value and analytical value are quite similar and they virtually equal.

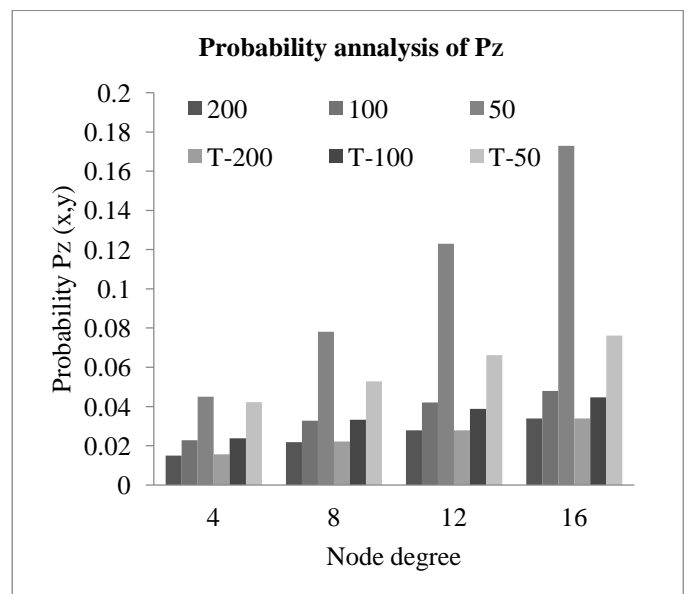

Fig. 6. Probability analysis for  $P_z(x, y)$

In Fig. 7, below the author computes the simulated value and analytical probability of  $P_X(x, y)$  by varying number of node or devices and node degree value. In figure we can see that when we increase the node degree  $a$  value the probability of collision also increases for all node sizes (50, 100, and 200). The probability of collision is high for smaller mesh network size (50) when compared to larger network size (200). And also we can see that simulation value and analytical value are quite similar and they virtually equal.

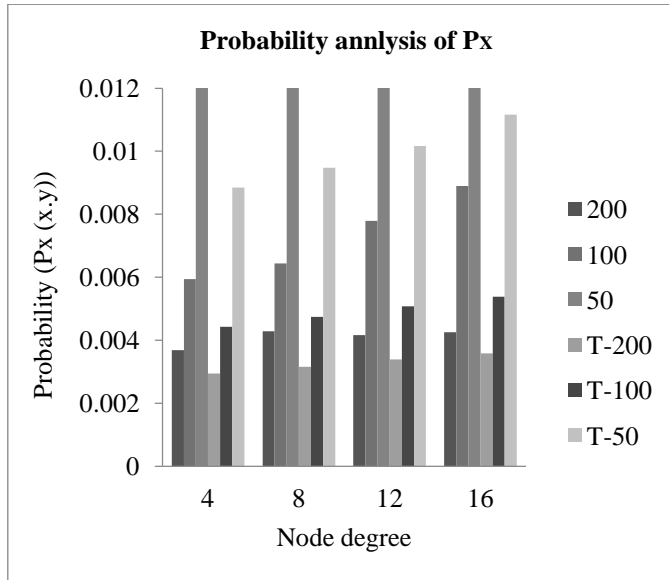

Fig. 7. Probability analysis for  $P_X(x, y)$

In Fig. 8, below the author computes the probability of  $P_X(x, y), P_Z(x, y), P_Y(x, y)$  by node degree value for 250 nodes or devices. In figure we can see that when we increase the node degree  $a$  value the probability of collision also increases. The probability of collision is high for  $P_Y(x, y)$ , the probability of collision is low for  $P_X(x, y)$  and the probability of collision for  $P_Z(x, y)$  lies between  $P_X$  and  $P_Y$ . Thus proving proposition 3  $P_Y(x, y) \geq P_Z(x, y) \geq P_X(x, y)$ .

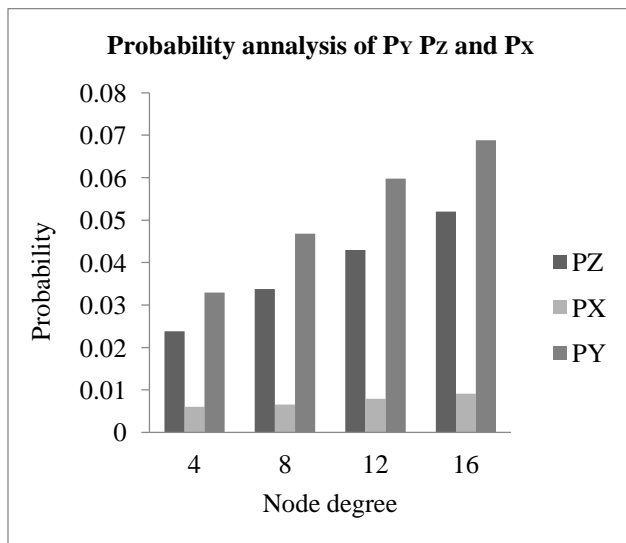

Fig. 8. Probability analysis

## VI. CONCLUSION

The paper presents a model that help in the design of MWNs that meets the QoS necessities of the end user. Here in this work we have presented a cross-layer based channel slot reutilization model based on node classification technique that minimizes the collision for channel slot re-utilization and thus helps in reducing latency for data transmission in WMN. We have conducted simulation and analytical study to find the risk involved in slot re-utilization. The experimental result shows the impact of proposed model on channel slot re-utilization due to overlapping result of both theoretical and simulation result. In future we would develop an adaptive channel slot re-utilization based MAC scheduling algorithm to improve QoS by reducing slot collision and conduct simulation sturdy for latency and compare our proposed model with other distributed, centralized or MAC based scheduling algorithm.

## REFERENCES

- [1] Chin-Ya Huang; Ramanathan, P., "Network Layer Support for Gigabit TCP Flows in Wireless Mesh Networks," in Mobile Computing, IEEE Transactions on, Vol. 14, No.10, pp.2073-2085, 2015.
- [2] Anusha, M.; Vemuru, S.; Gunasekhar, T., "TDMA-based MAC protocols for scheduling channel allocation in multi-channel wireless mesh networks using cognitive radio," in Circuit, Power and Computing Technologies (ICCPCT), International Conference on, pp.1-5, 2015.
- [3] Djukic, P.; Valaee, S., "Distributed Link Scheduling for TDMA Mesh Networks," in Communications, 2007. ICC '07. IEEE International Conference on, pp.3823-3828, 24-28 2007.
- [4] Yu Cheng; Hongkun Li; Peng-Jun Wan; Xinbing Wang, "Wireless Mesh Network Capacity Achievable Over the CSMA/CA MAC," in Vehicular Technology, IEEE Transactions on, vol.61, no.7, pp.3151-3165, 2012.
- [5] Teymouri, Peyman; Yazdani, Nasser; Khonsari, Ahmad, "DT-MAC: An Efficient and Scalable Medium Access Control Protocol for Wireless Networks," in Wireless Communications, IEEE Transactions on, Vol. 12, No. 3, pp.1268-1278, 2013.
- [6] Sevani, V.; Raman, B.; Joshi, P., "Implementation-Based Evaluation of a Full-Fledged Multihop TDMA-MAC for WiFi Mesh Networks," in Mobile Computing, IEEE Transactions on, Vol. 13, No.2, pp.392-406, 2014.
- [7] Xin Zhao; Jun Guo; Chun Tung Chou; Misra, A.; Jha, S.K., "High-Throughput Reliable Multicast in Multi-Hop Wireless Mesh Networks," in Mobile Computing, IEEE Transactions on, Vol.14, No.4, pp.728-741, April 1 2015.
- [8] Khasawneh, F.A.; Benmimoune, A.; Kadoch, M.; Khasawneh, M.A., "Predictive Congestion Avoidance in Wireless Mesh Network," in Future Internet of Things and Cloud (FiCloud), 2015 3<sup>rd</sup> International Conference on, pp.108-112, 24-26 Aug. 2015.
- [9] Ouni, A.; Rivano, H.; Valois, F.; Rosenberg, C., "Energy and Throughput Optimization of Wireless Mesh Networks With Continuous Power Control," in Wireless Communications, IEEE Transactions on, Vol. 14, No.2, pp.1131-1142, 2015.
- [10] Rabarijaona, V.H.; Kojima, F.; Harada, H., "Hierarchical mesh tree protocol for efficient multi-hop data collection," in Wireless Communications and Networking Conference (WCNC), 2014 IEEE, pp.2008-2013, 6-9 April 2014.

- [11] Safronov, R.; Bakhtin, A.; Muravyev, I.; Muratchaev, S., "Designing roadside mesh network with TDMA," in Ultra Modern Telecommunications and Control Systems and Workshops (ICUMT), pp.131-135, 2014.
- [12] K. Bilstrup. A survey regarding wireless communication standarts intended for a high-speed mobile environment// Technical Report IDE, 2007.
- [13] G. Zhou, T. He, S. Krishnamurthy, and J.A. Stankovic, "Models and Solutions for Radio Irregularity in Wireless Sensor Networks," ACM Trans. Sensor Networks, Vol. 2, No. 2, pp. 221-262, 2006.
- [14] F. Kuhn, R. Wattenhofer, and A. Zollinger, "Ad Hoc Networks beyond Unit Disk Graphs," Wireless Networks, pp. 715-729, 2008.
- [15] P. Hall, Introduction to the Theory of Coverage Processes. John Wiley and Sons, 1988.
- [16] I. Stojmenovic, A. Nayak, and J. Kuruvila, "Design Guidelines for Routing Protocols in Ad Hoc and Sensor Networks with a Realistic Physical Layer," IEEE Trans. Comm., vol. 43, no. 3, pp. 101-106, 2005.
- [17] L.-H. Yen and Y.-M. Cheng, "Clustering Coefficient of Wireless Ad Hoc Networks and the Quantity of Hidden Terminals," IEEE Comm. Letter, Vol. 9, No. 3, pp. 234-236, 2005.
- [18] A. Dhananjay, H. Zhang, J. Li, and L. Subramanian, "Practical, distributed channel assignment and routing in dual-radio mesh networks," SIGCOMM, 2009.
- [19] K. Chebrolu and A. Mishra, "Loss behavior analysis and its application in design of link quality metrics," in COMSNETS, 2011.
- [20] S. Xu and T. Saadawi, "Revealing the problems with 802.11 medium access control protocol in multi-hop wireless ad hoc networks," Computer Networks, vol. 38, no. 4, 2002.
- [21] P. Djukic and P. Mohapatra, "Soft-TDMAC: A Software TDMA-based MAC over Commodity 802.11 hardware," in INFOCOM 2009.
- [22] A. Koubaa, A. Cunha, M. Alves, and E. Tovar, "TDBS: A Time Division Beacon Scheduling Mechanism for ZigBee Cluster-Tree Wireless Sensor Networks," Real-Time Systems J., Vol. 40, No. 3, pp. 321-354, Dec. 2008.
- [23] M.-S. Pan and Y.-C. Tseng, "Quick Convergecast in ZigBee Beacon-Enabled Tree-Based Wireless Sensor Networks," Computer Comm., vol. 31, pp. 999-1011, 2008.
- [24] Sevani, V.; Raman, B.; Joshi, P., "Implementation-Based Evaluation of a Full-Fledged Multihop TDMA-MAC for WiFi Mesh Networks," in Mobile Computing, IEEE Transactions on, Vol.13, No.2, pp.392-406, 2014.
- [25] S. Xu and T. Saadawi, "Revealing the problems with 802.11 medium access control protocol in multi-hop wireless ad hoc networks," Computer Networks, vol. 38, no. 4, 2002.



**Asha C N** received the Bachelor of Engineering degree in Electronics and Communication Engineering from Bangalore University in 2002 and Master of Technology degree in VLSI Design & Embedded from Visvesvaraya Technological University (VTU) in 2008. She is an assistant professor in Electronics and Communication Engineering Department, Acharya Institute of Technology since 2007. Her research interest includes Wireless Mesh Network (WMN), Cross Layer Design and Routing protocols. She is life member of Indian Society of Technical Education (ISTE).



**T G Basavaraju** received Ph.D. (Engg) from Jadavpur University, Kolkata in the area of Mobile Adhoc Networks. He obtained his Master Degree in Computer Science and Engineering from Visveswaraya College of Engineering (UVCE), Bangalore University. He holds Bachelor's degree in Computer Science and Engineering from Kuvempu University. His areas of research are Wireless Ad hoc Networks, Sensor Networks and Mesh networks. He has to his credit more than 65 research publications in National/International Journals and Conferences. He is currently Professor and Head of Computer Science and Engineering Department at Government SKSTI, Bangalore and has 20 years of experience.